

70207+70211

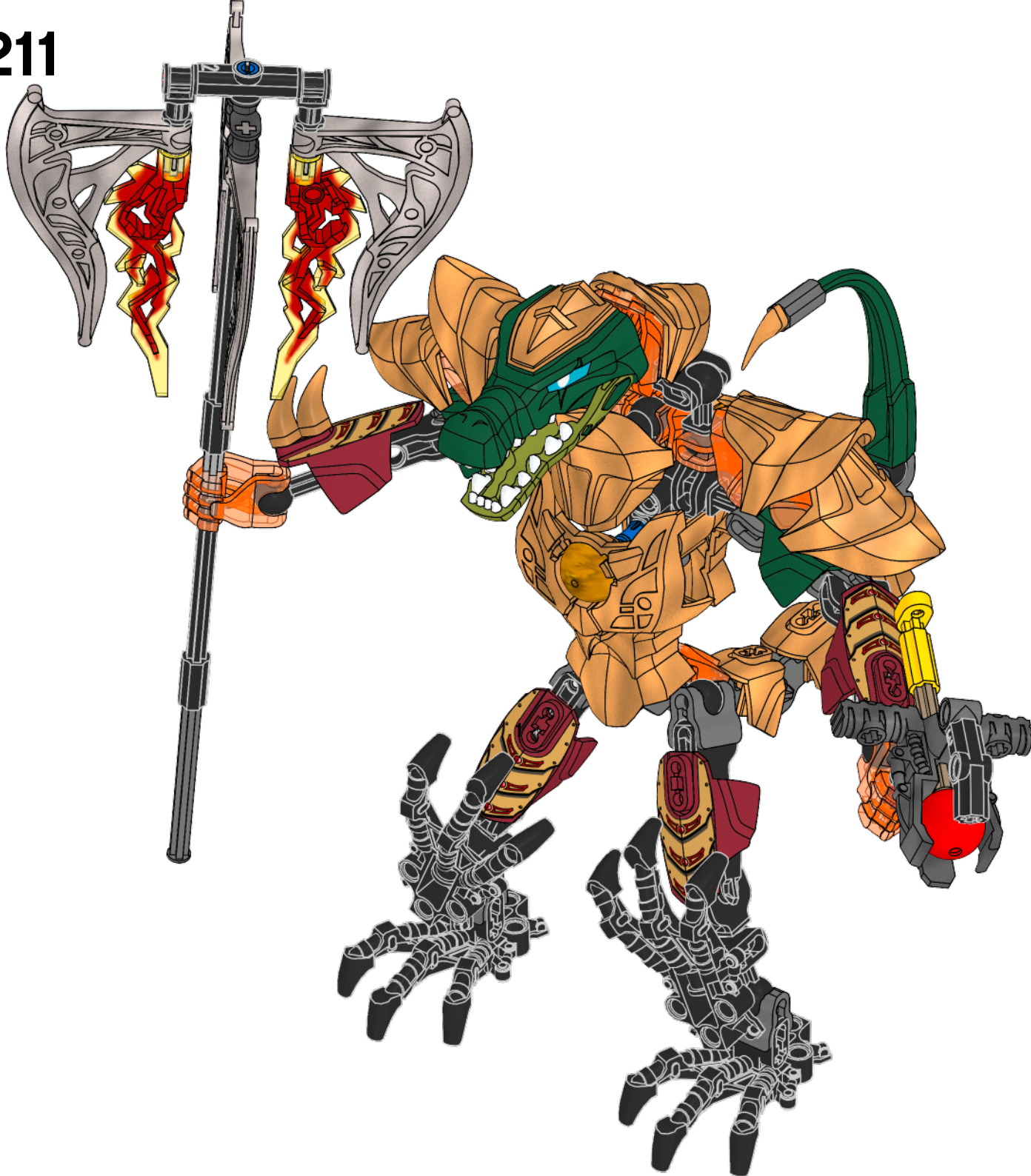

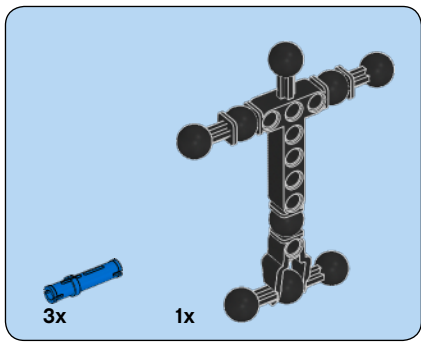

1

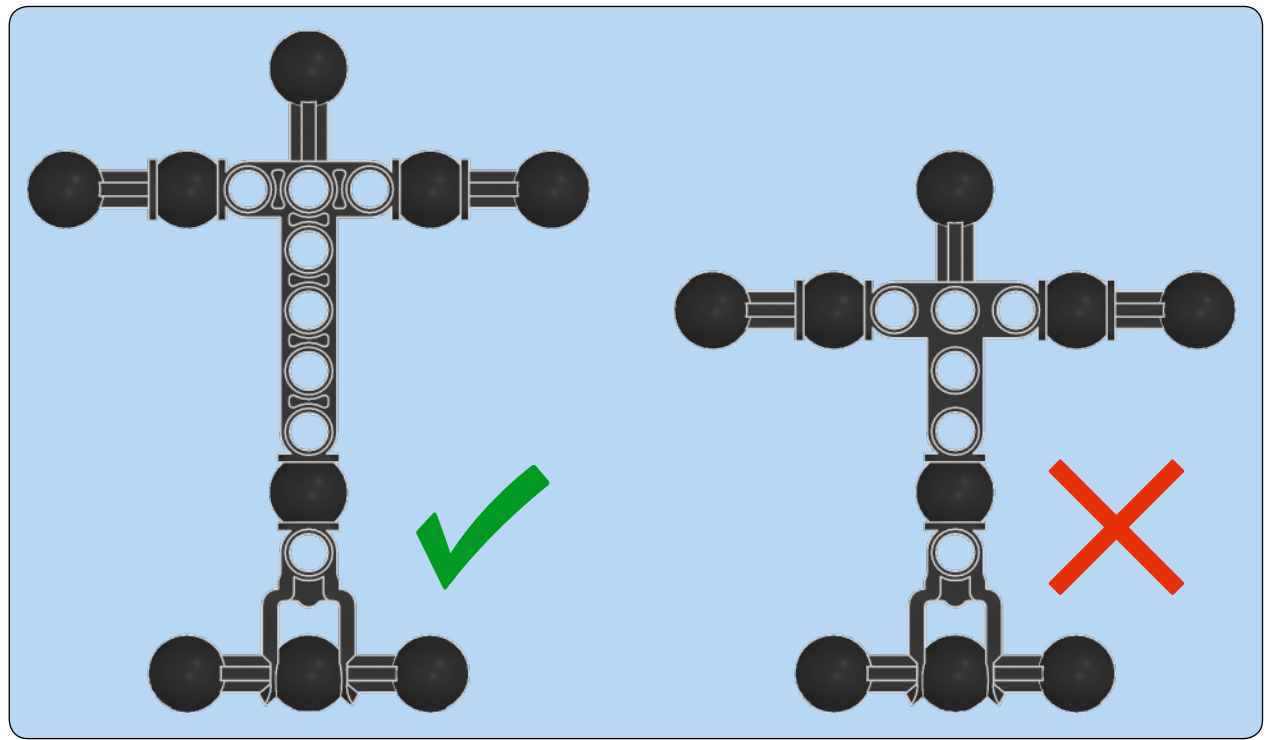
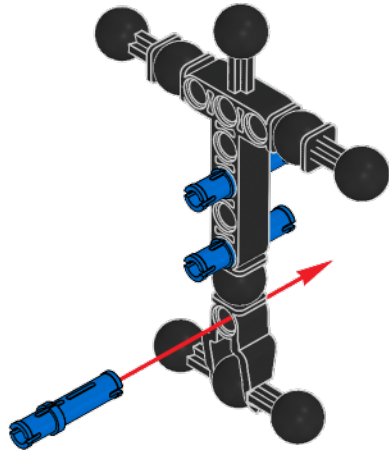

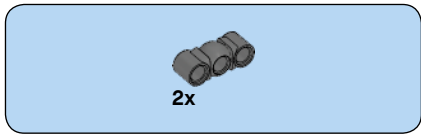

2

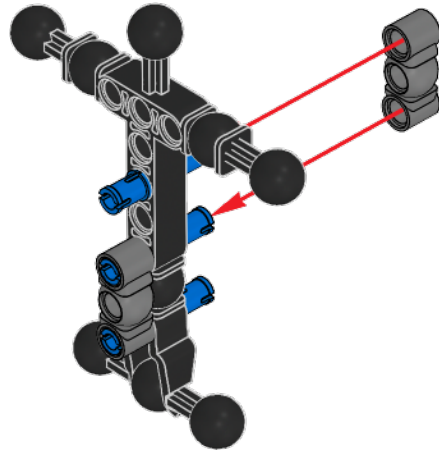

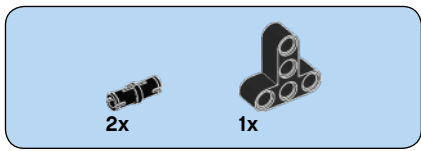

3

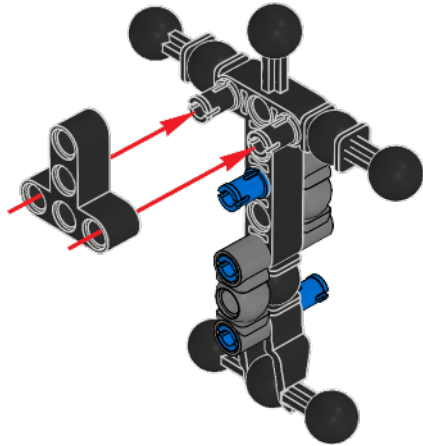

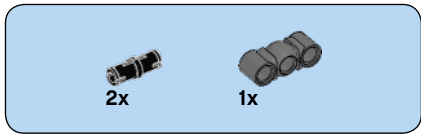

4

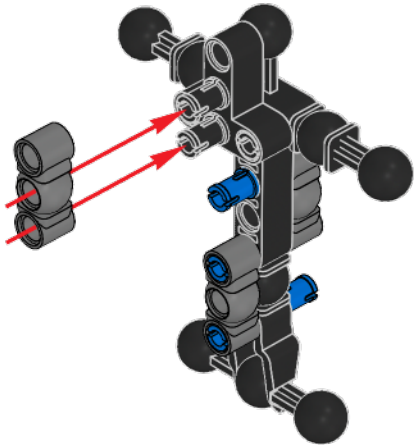

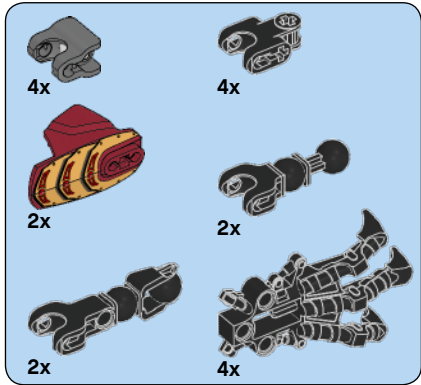
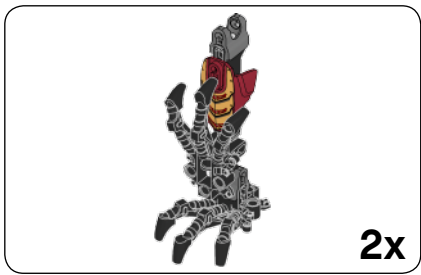

# 5

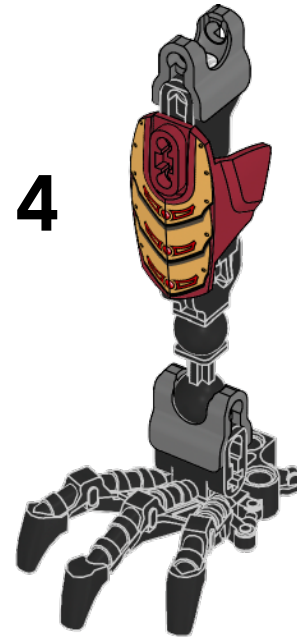
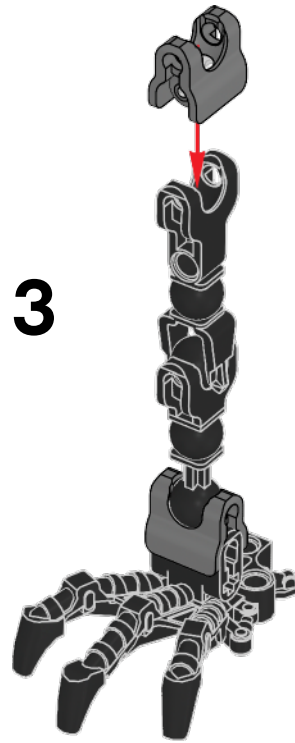
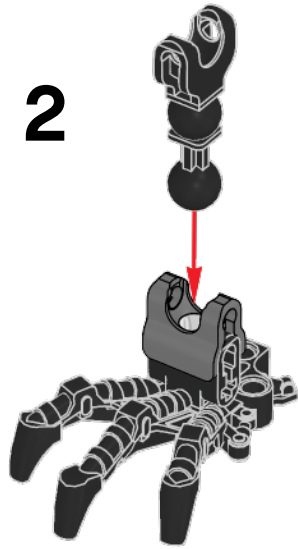
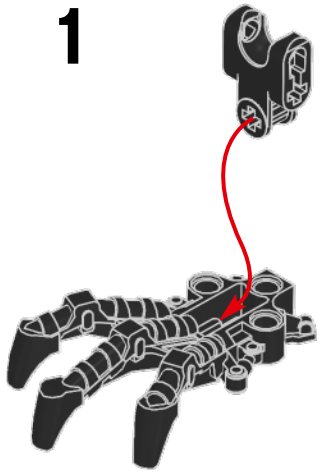

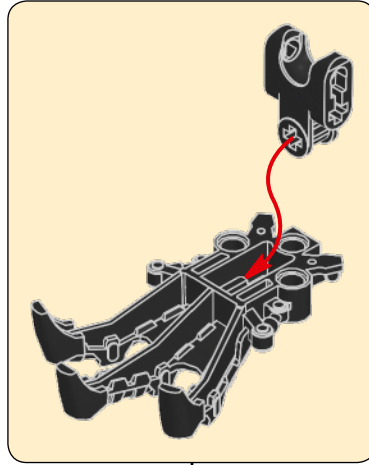

**5**

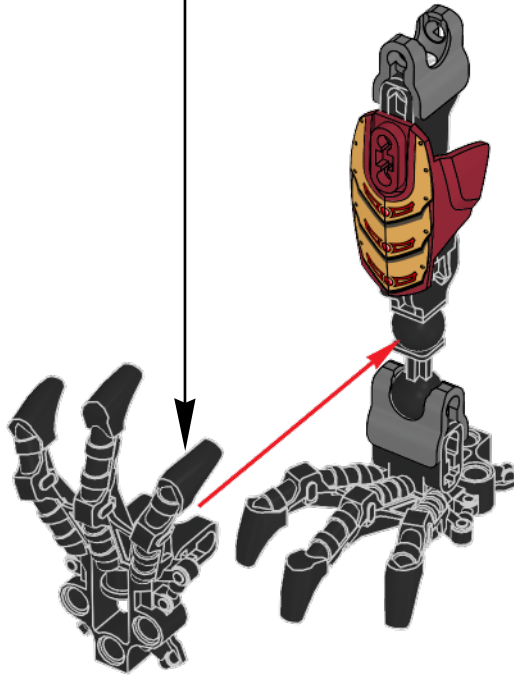

**2x**

6

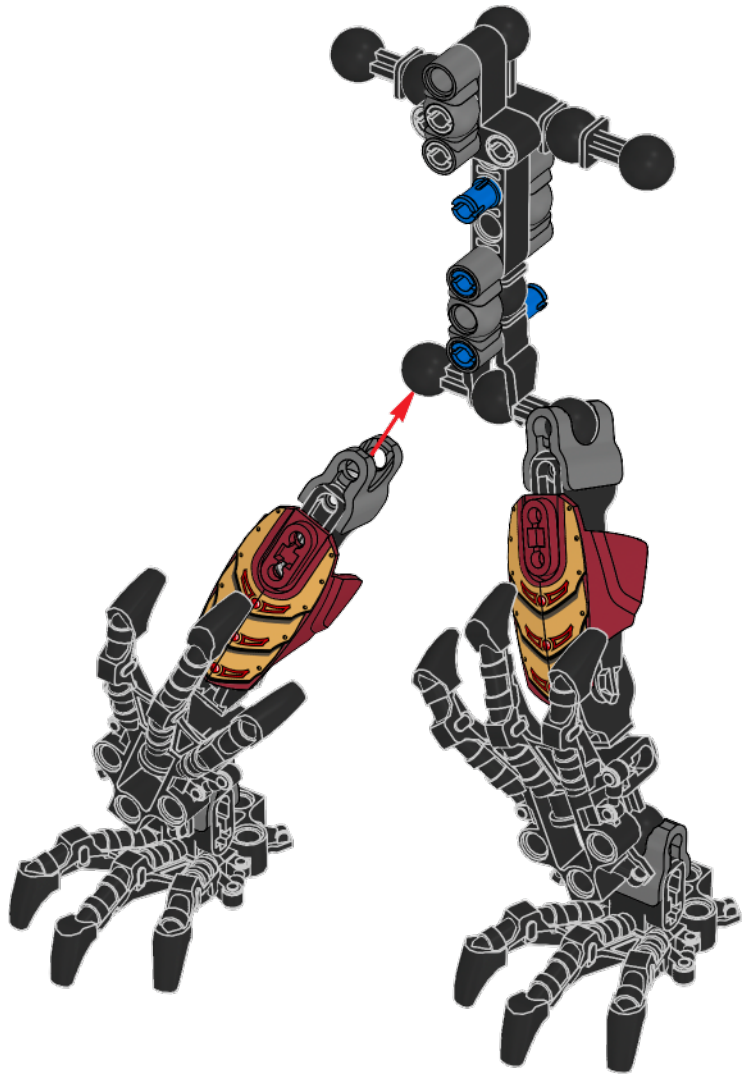



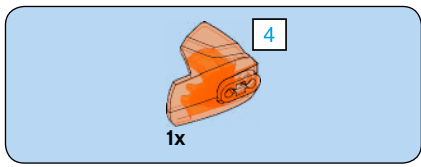

7

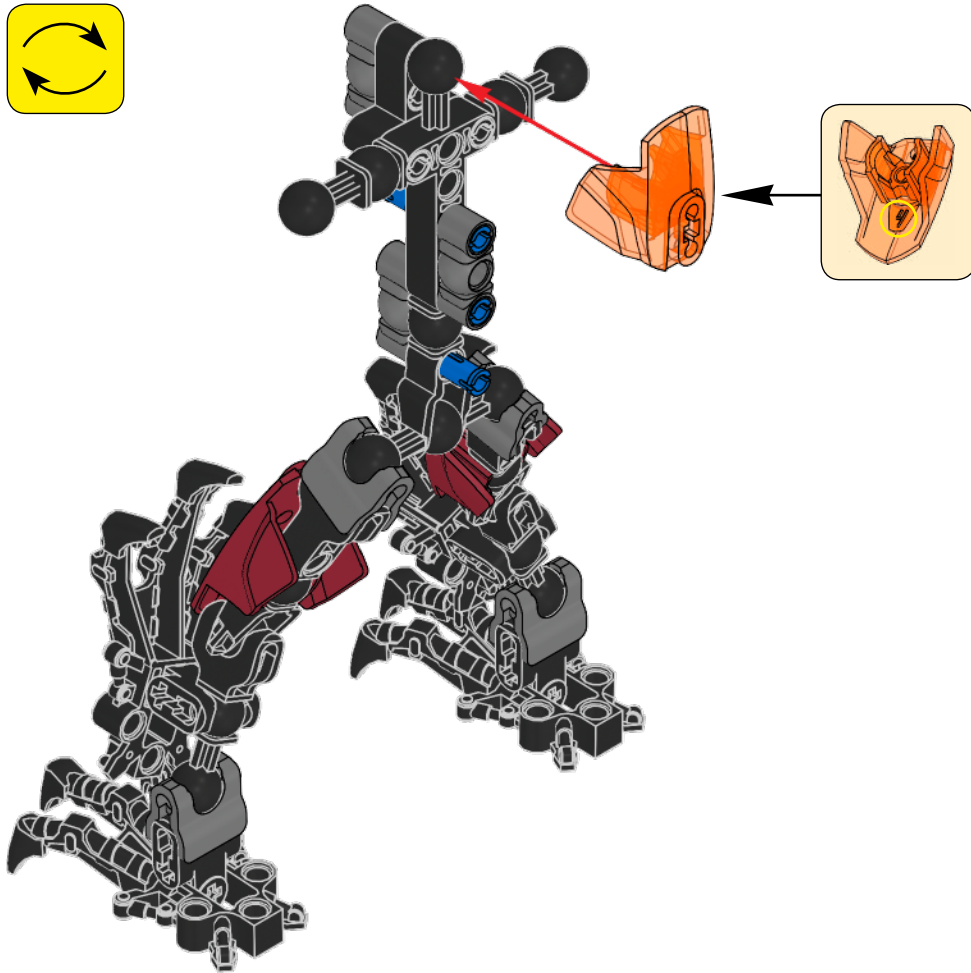

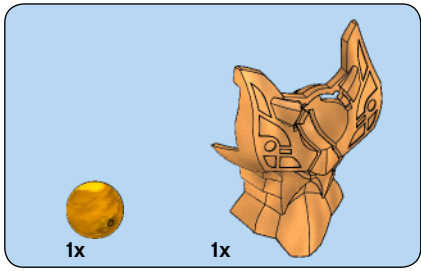

8

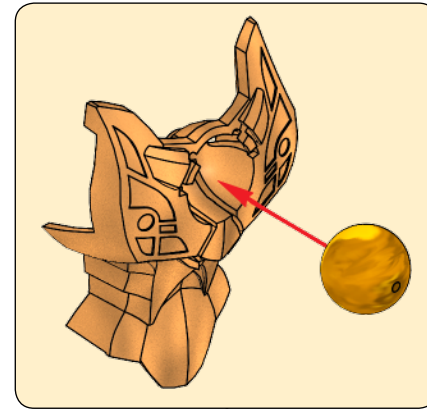
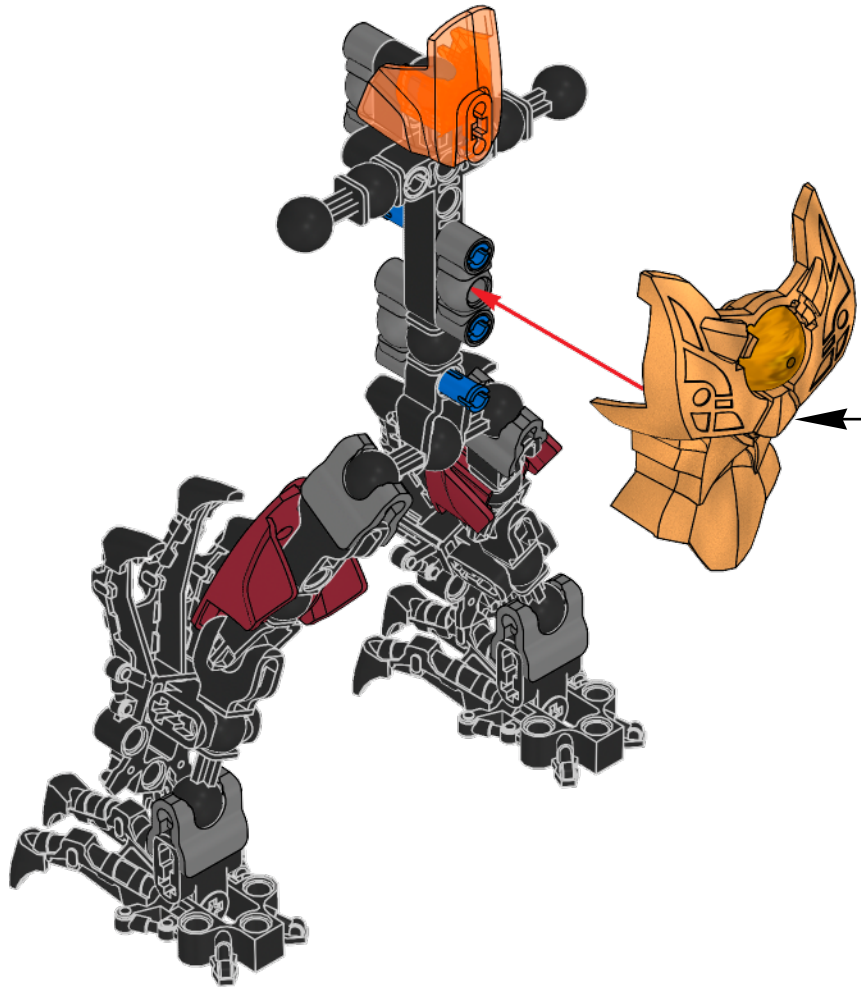

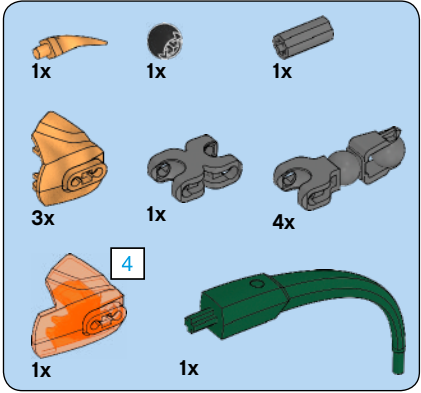
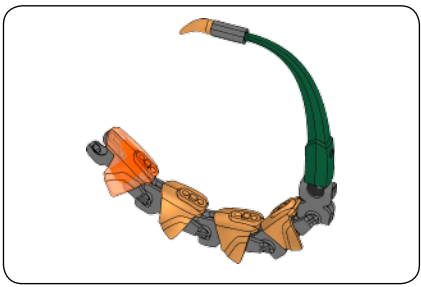

9

1

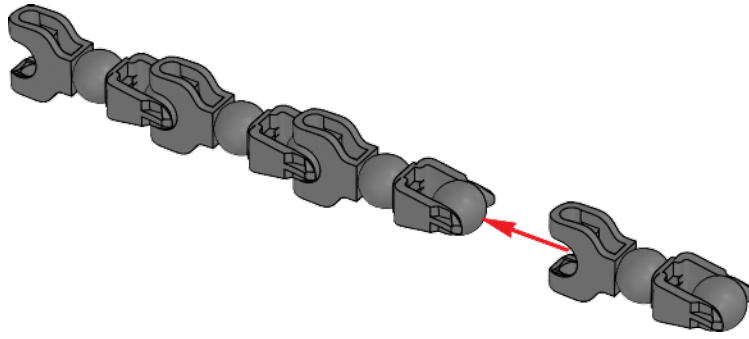

2

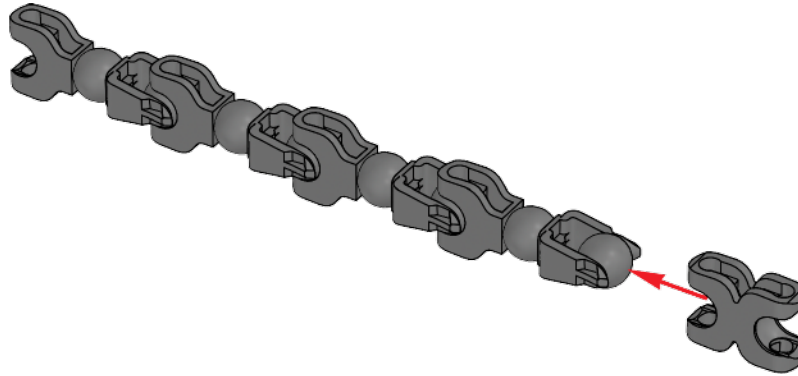

3

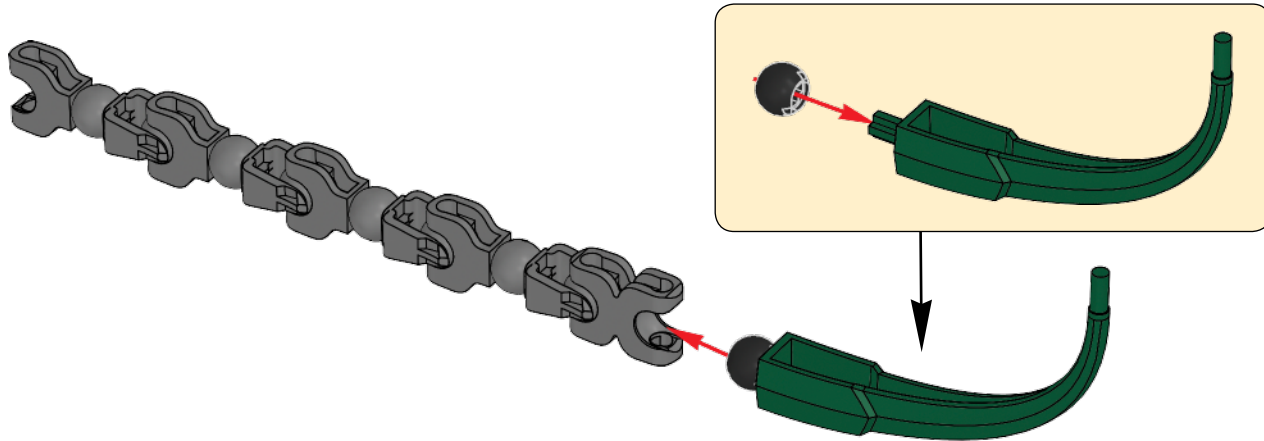

4

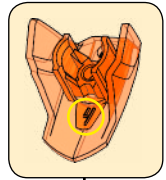
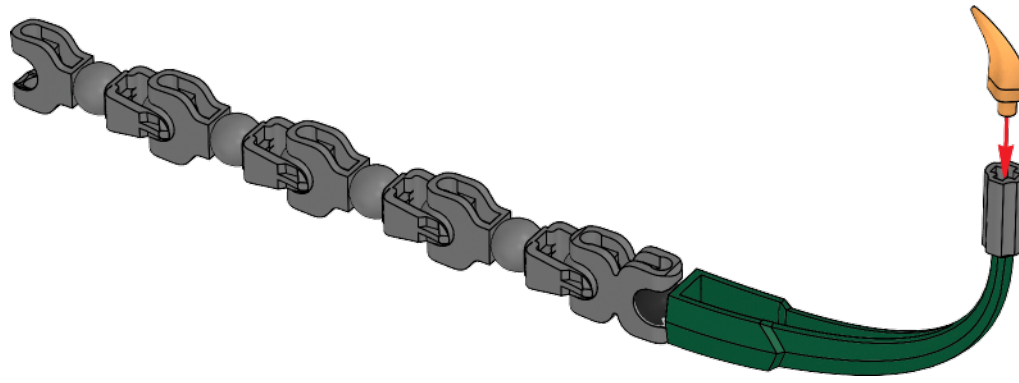

5

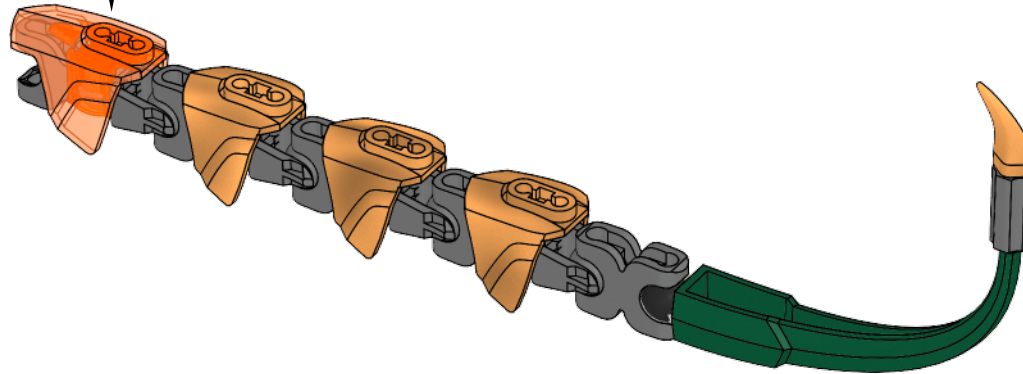

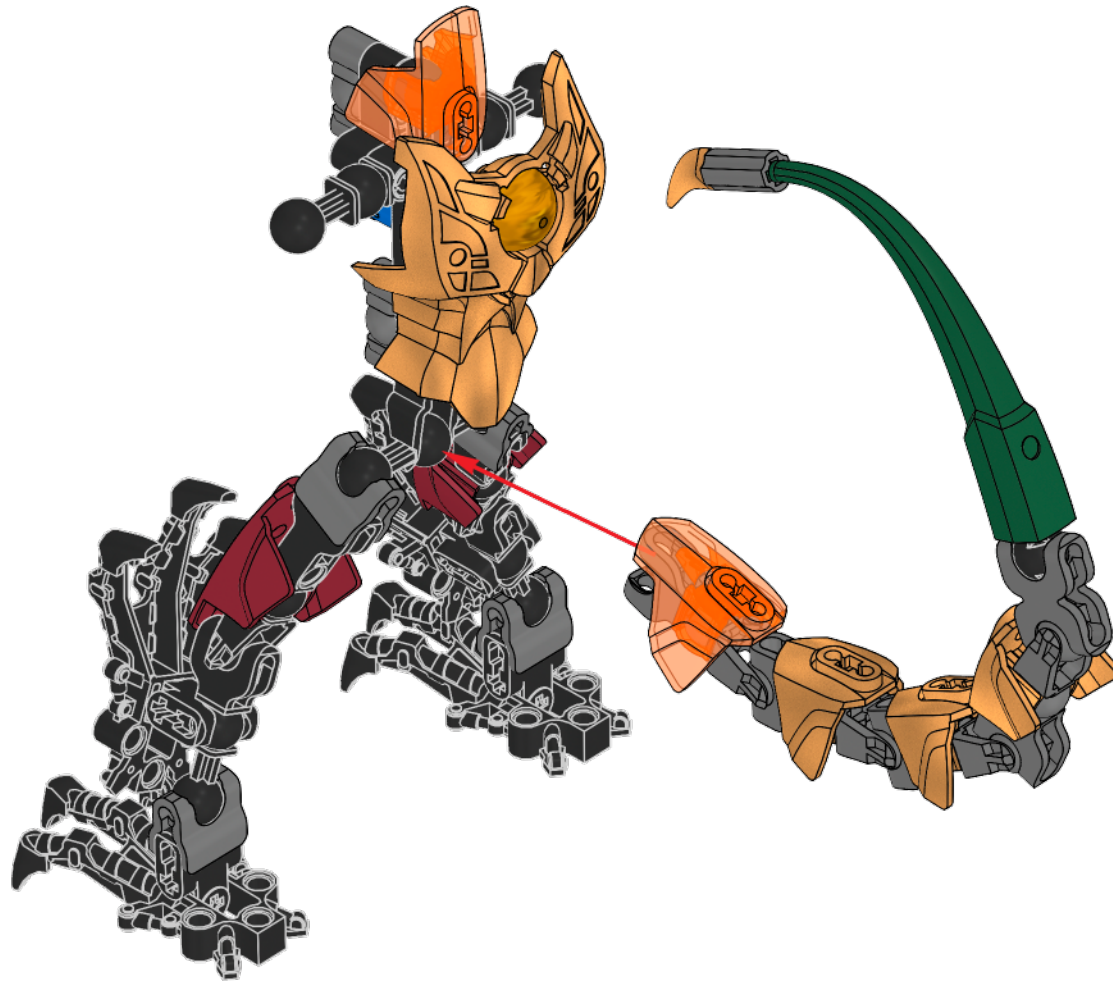

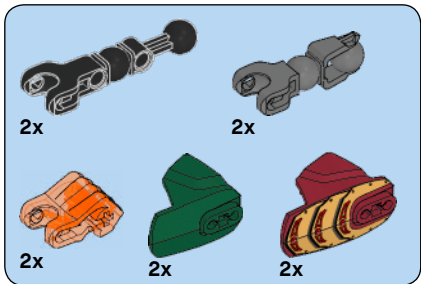
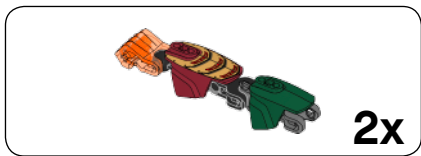

11

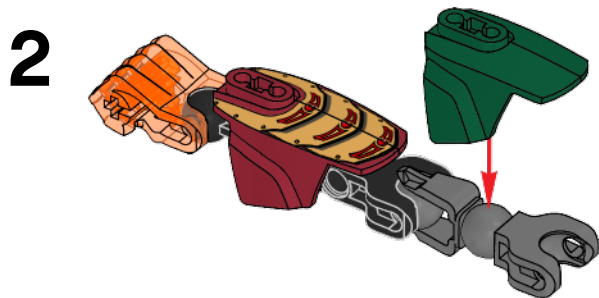
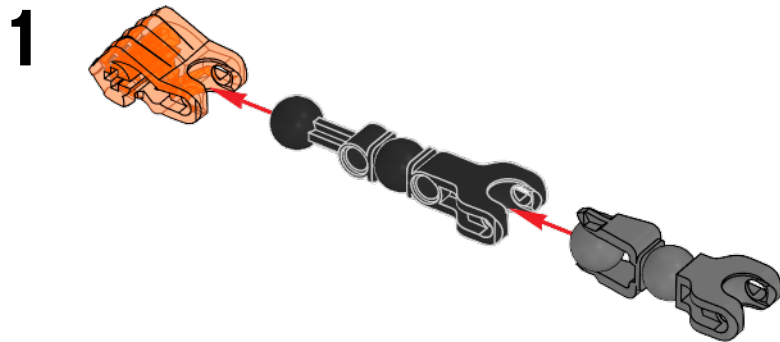

2x

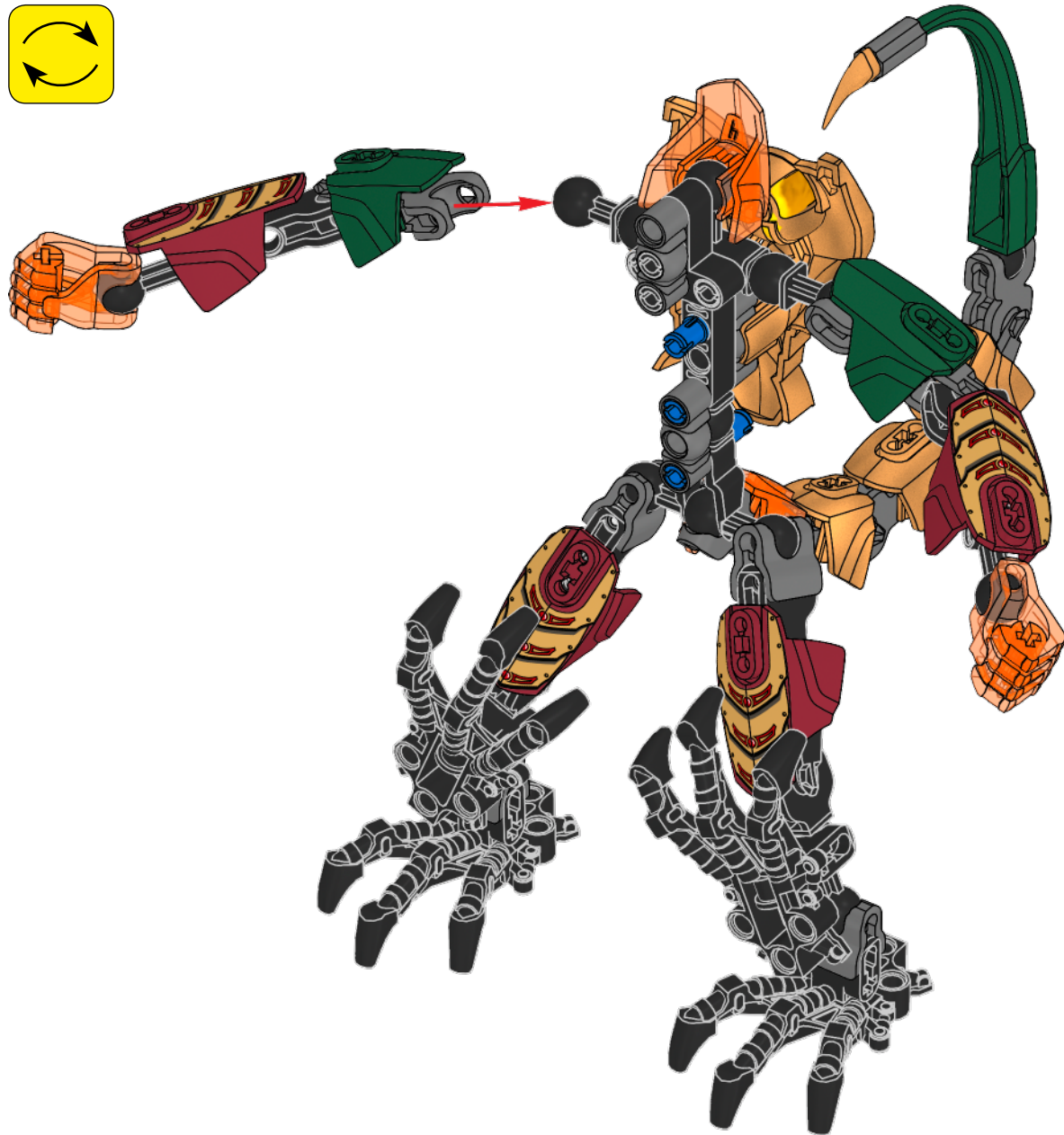
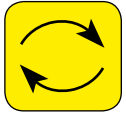

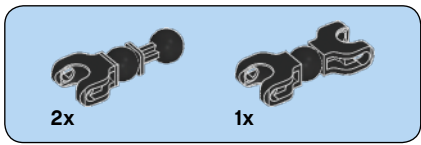

13

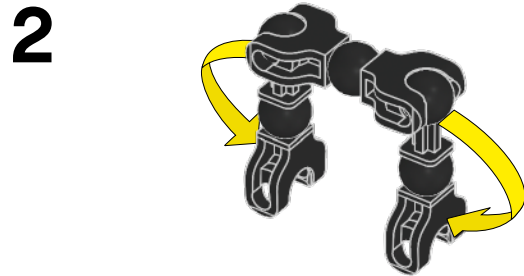
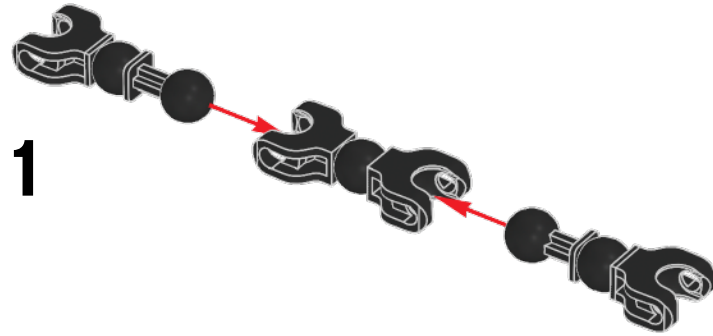



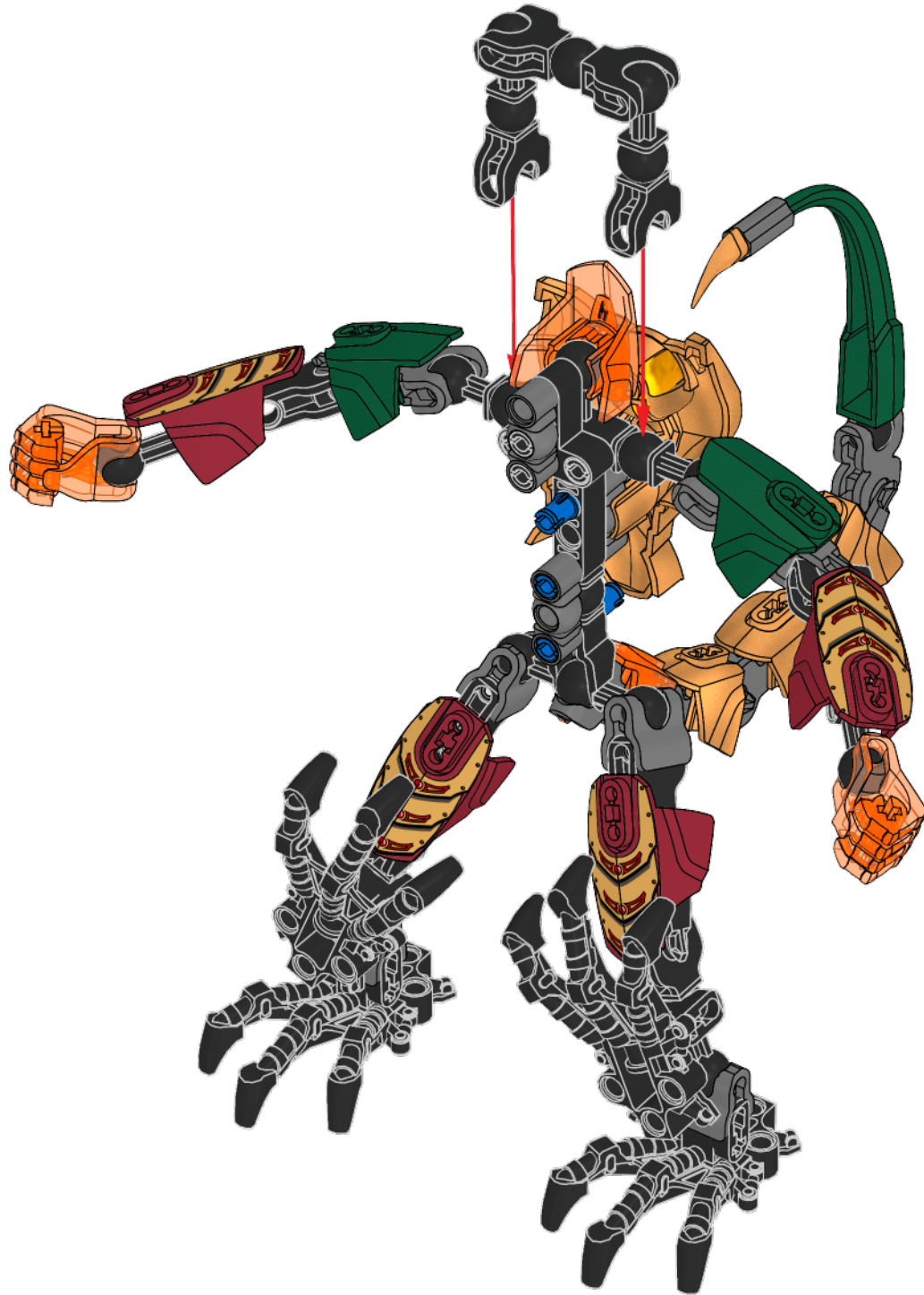

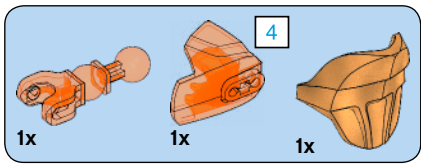

15

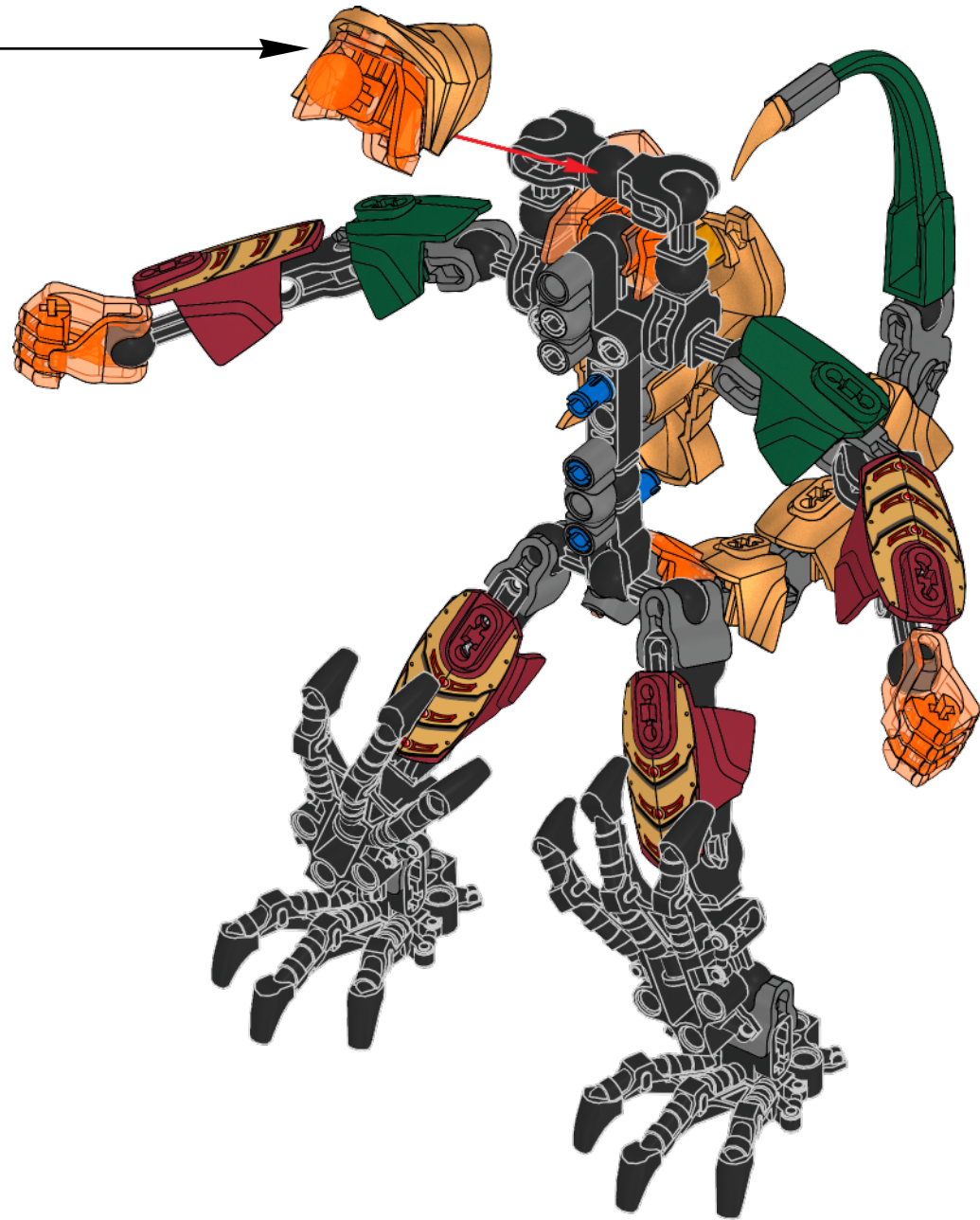
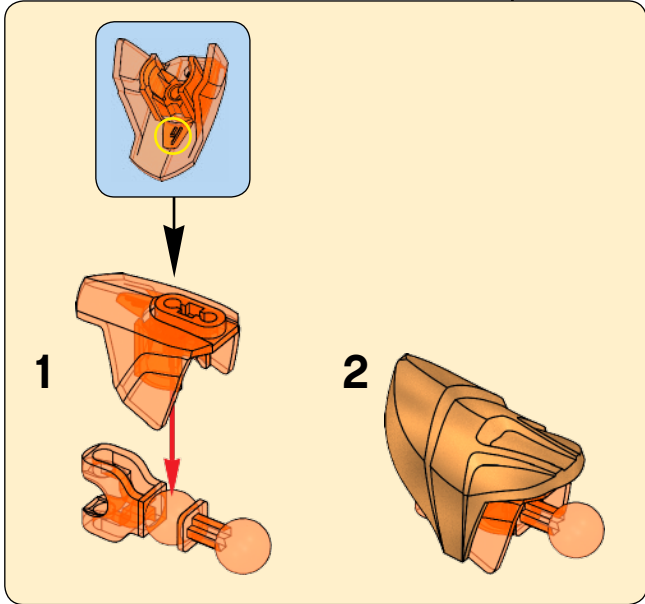

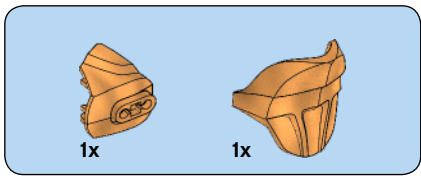

16

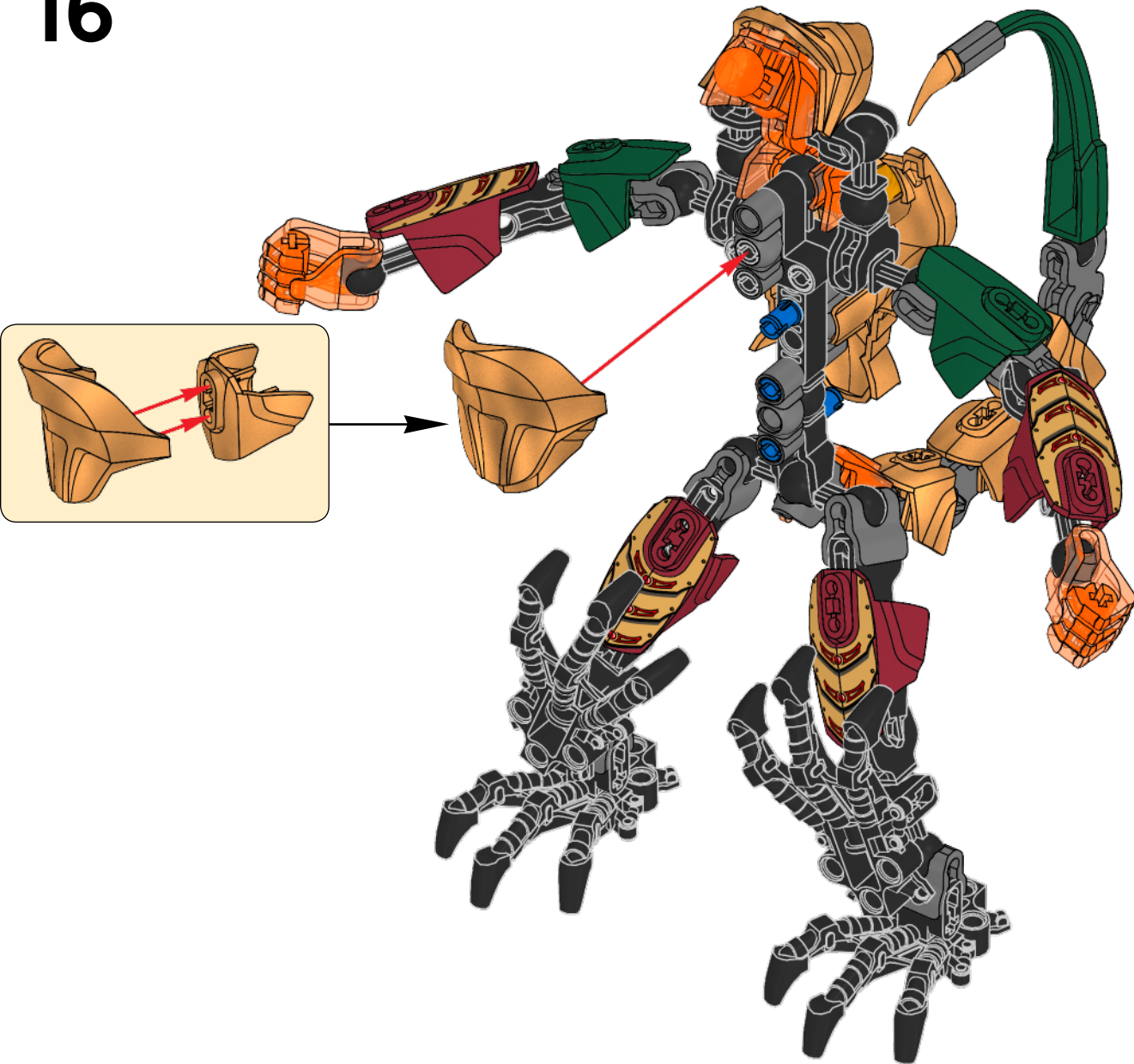

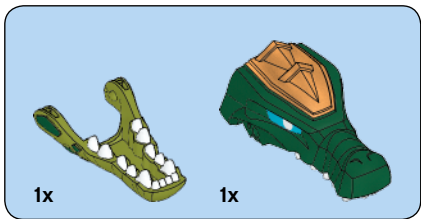

17

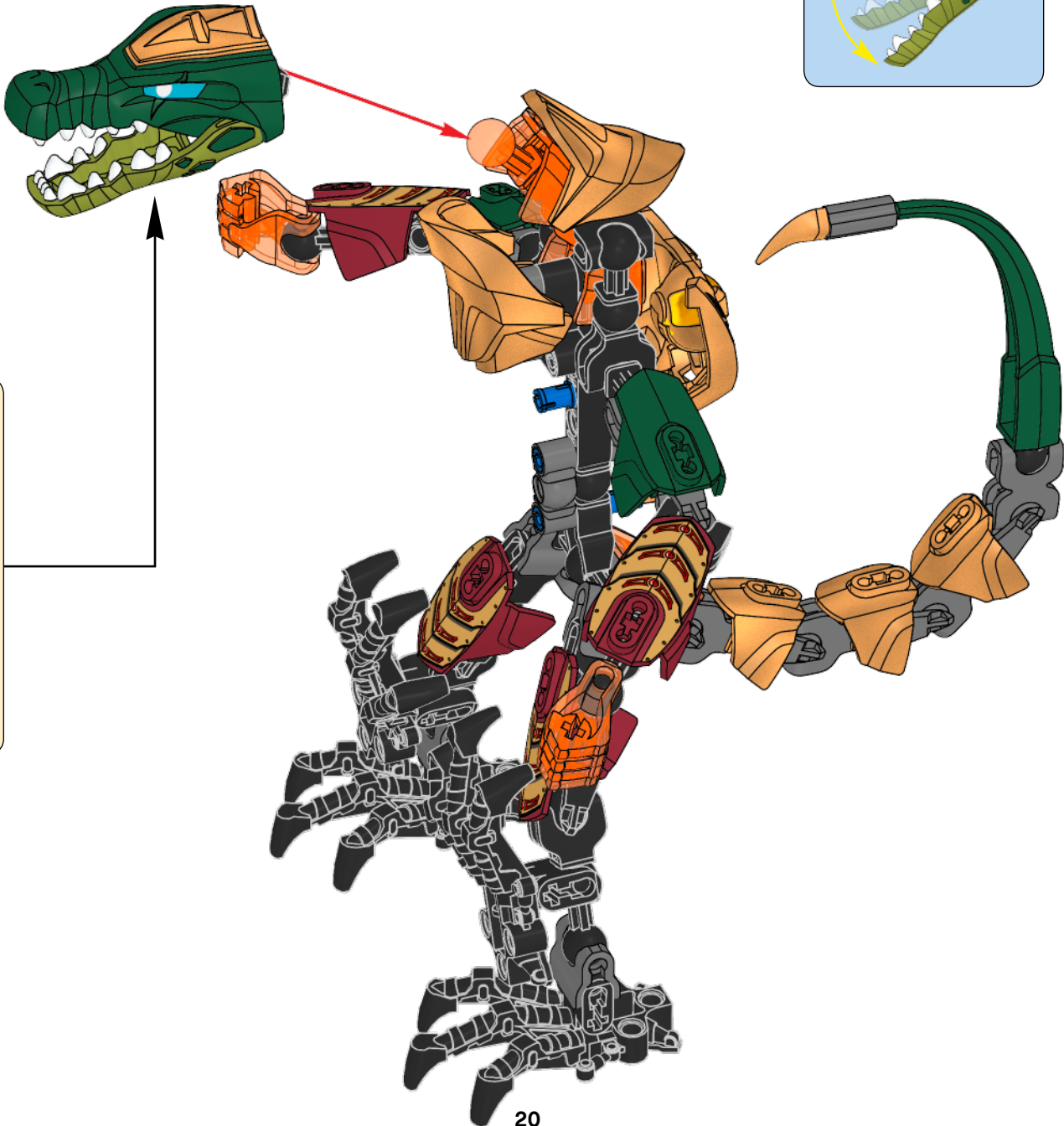
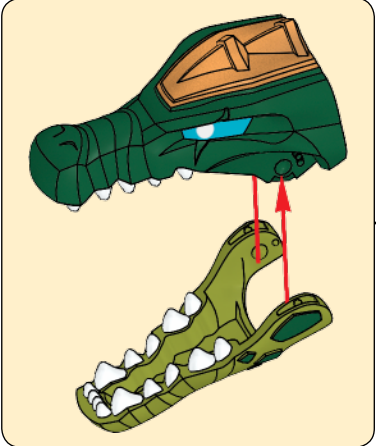

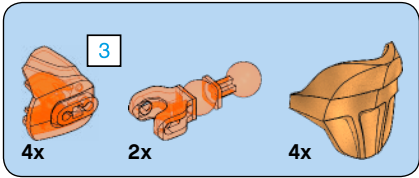

18

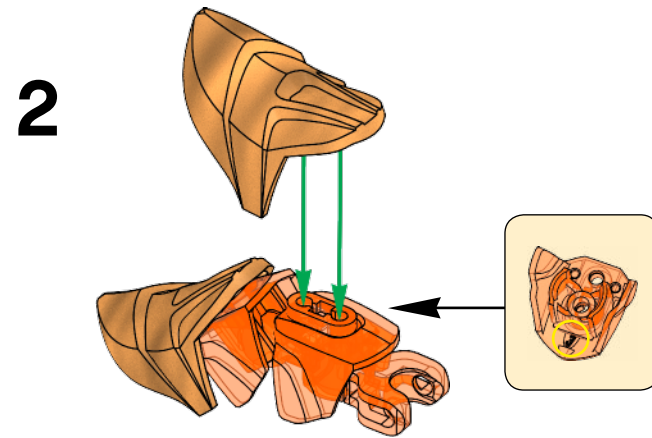
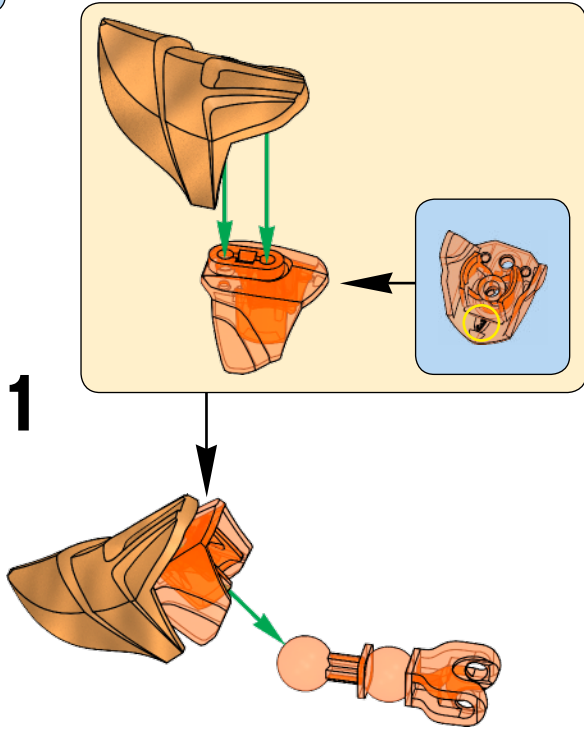

2x

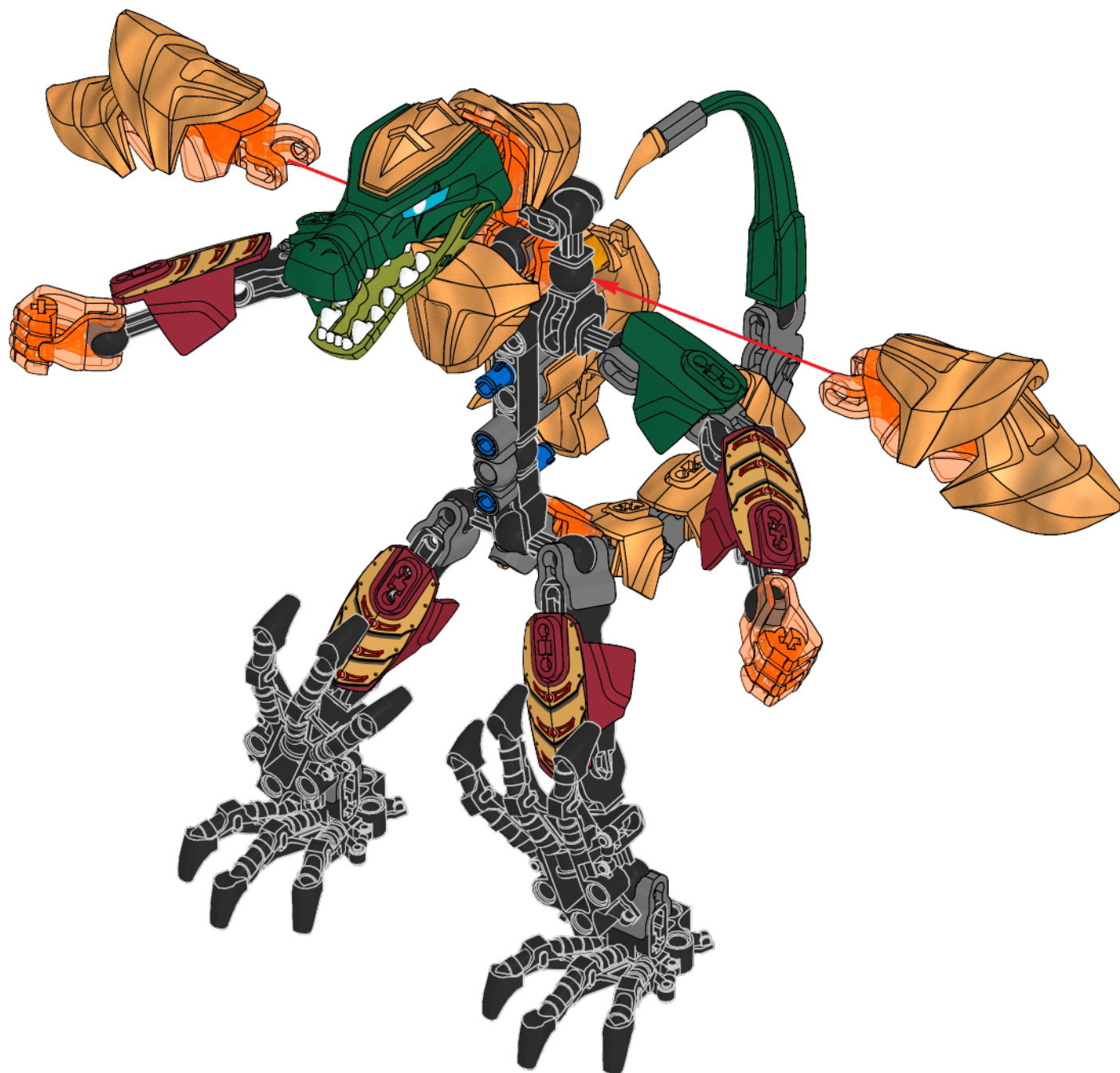

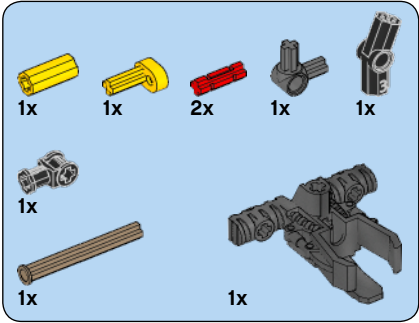
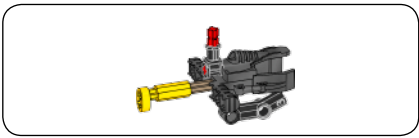

# 20

1

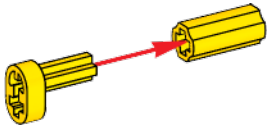

2

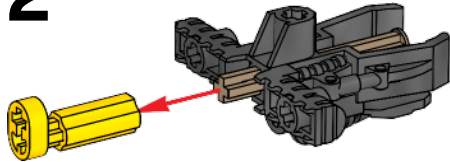

3

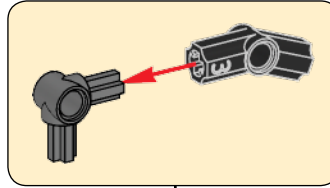
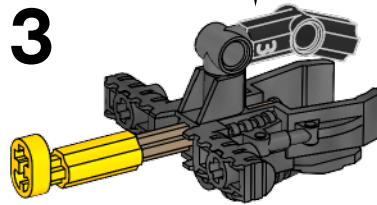

4

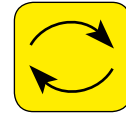
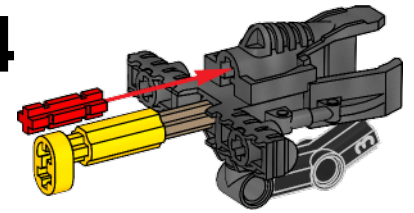

5

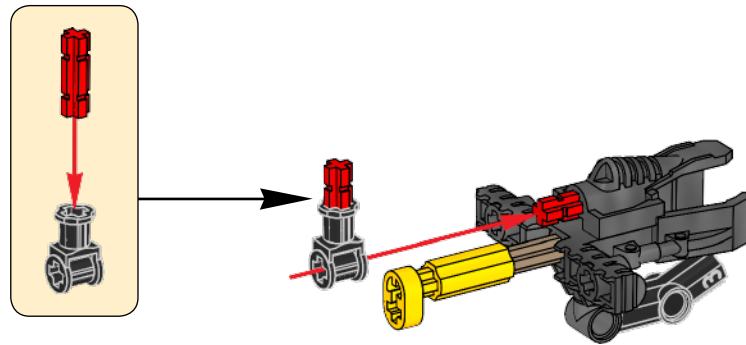



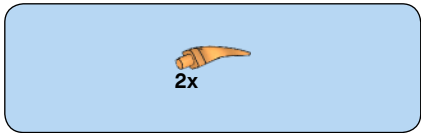

21



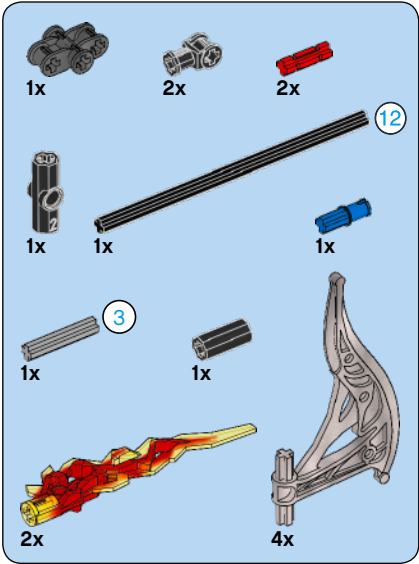
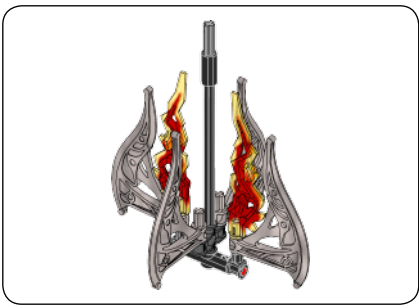

# 22

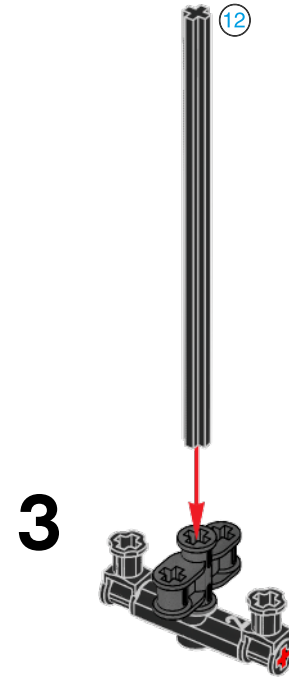
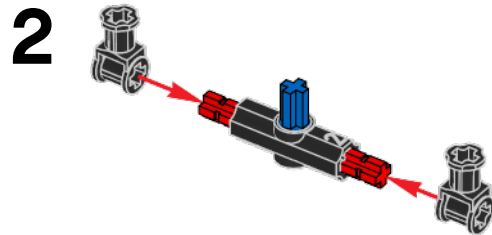
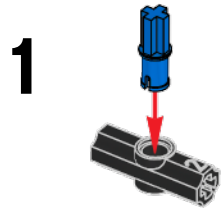

4

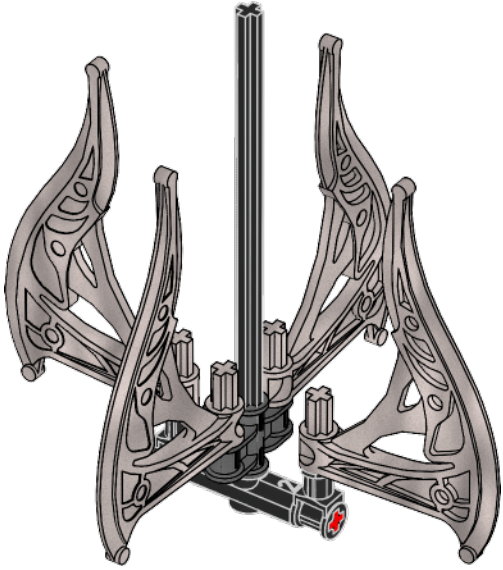

5

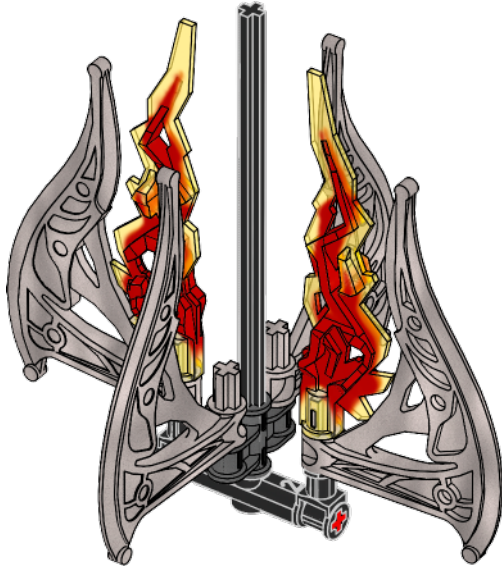

6

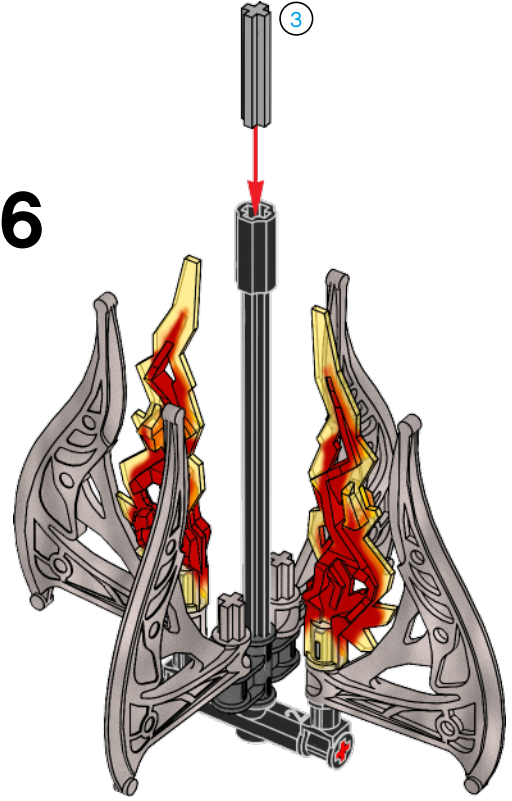





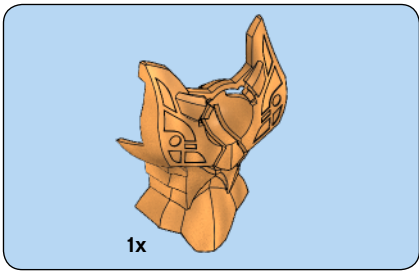

25

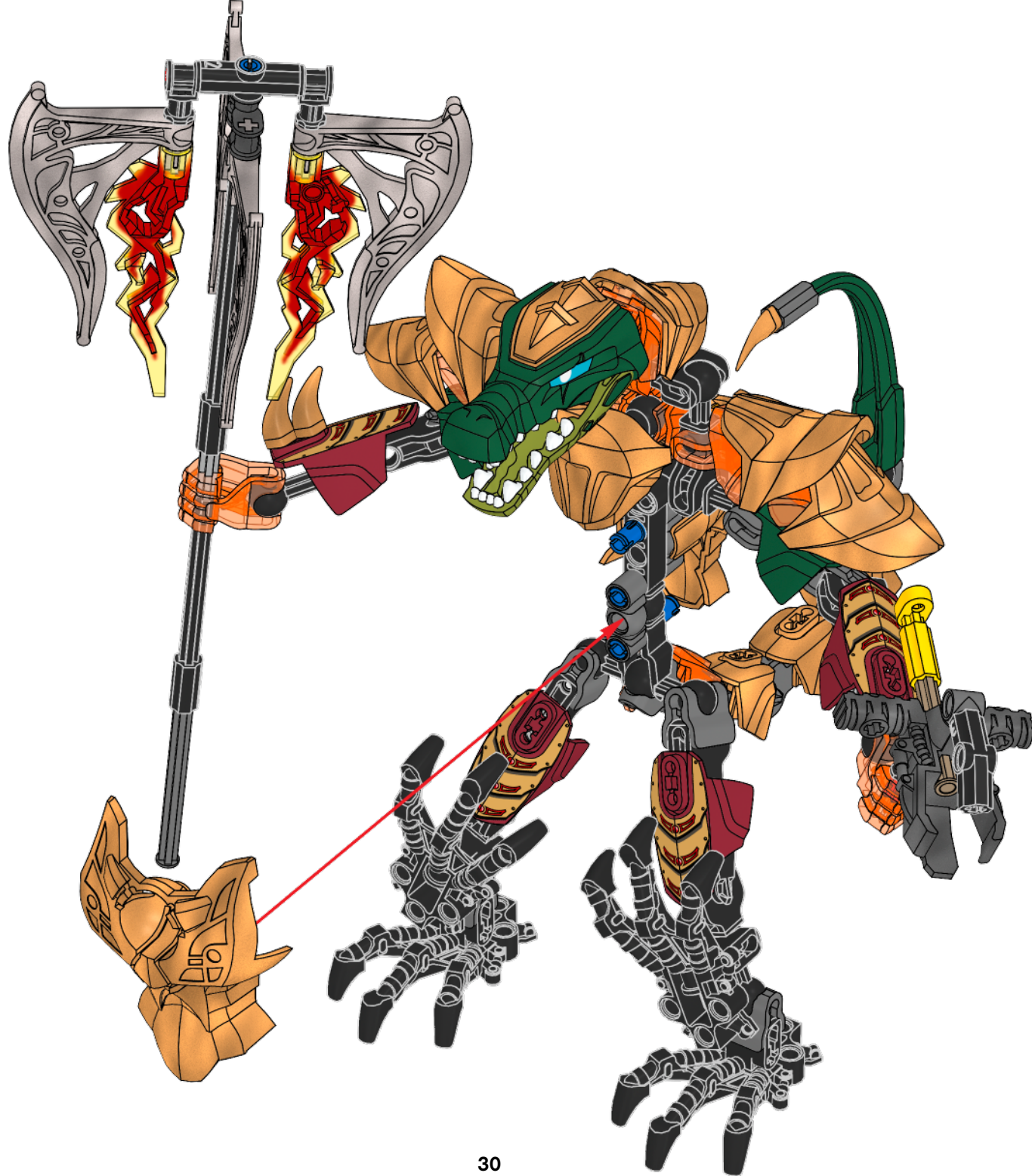

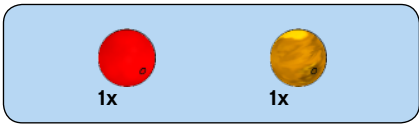

26

